



ENHANCED CONTAINER SYSTEMS

SEA BOX, Inc. is a Proud United States Small Business Manufacturer!



1 SEA BOX Drive, East Riverton, NJ 08077
Phone: 856-303-1101 Fax: 856-303-1501
www.seabox.com

SEA BOX Containers



SEA BOX is a world leader in container design, custom modification and manufacturing. Our containers are used by all branches of the military and commercial customers throughout the world.



We now offer enhanced containers that feature removable storage modules. These drawer and shelf modules provide a way to effectively use containers for the transport and storage of small, medium and large sized parts, tools, supplies and other materials that may be needed in the field.

Storage modules are secured in the containers with adaptor plates and can be used in Quadcons, Tricons, Bicons and 20' ISO.

Selecting the Container and Removable Storage Modules That is Right for Your Needs



- **STEP 1:** Select the enhanced container size that fits your storage and transportation needs
 - Choose Quadcon, Tricon, Bicon, or 20' ISO Containers
- **STEP 2:** Decide if you need Removable Storage Modules on one or both sides of your container. Selecting a Module for just one side allows for bulk items to be stored in the same container. Selecting Modules for both sides maximizes storage of small, medium and large items, parts or supplies.

Selecting the Container and Removable Storage Modules That is Right for Your Needs



- **STEP 3:** Evaluate the items, parts or supplies that will be stored and transported to determine the correct type of Removable Storage Modules.
 - Small and medium sized items (tools, medical supplies, small replacement parts, etc.) will be stored and transported best in Drawer Modules
 - Larger items (batteries, engines, etc.) will be stored and transported best in Glide Out Shelving Modules



Selecting the Container and Removable Storage Modules That is Right for Your Needs



- **STEP 4:** Select your storage modules and build your enhanced container system!

Modules are available in the following sizes to match the container size and number of adaptor plates you've selected:

- Quadcon size (fits in Quadcons or Bicons). Select one module per adaptor plate.
- Tricon Half-Width size (fits Tricons and 20' ISO containers). Select two modules per adaptor plate.
- Tricon Full-Width size (fits Tricons and 20' ISO containers). These are Glide Out Shelving Modules. Select one per adaptor plate.

You can build your enhanced containers with variety of modules to accommodate all sized items!





TRICON & 20-FOOT ENHANCED CONTAINERS AND STORAGE MODULES



Tricon (Type II) Containers with Adaptor Plates on One or Both Sides



Adaptor Plate Mounted on One Side Accepts any One Full-Width Storage Module or any Two Half-Width Storage Modules

P/N: [SB822.0.ST.FAPT1.DLA](#) NSN:8150-01-618-6802

P/N: [SB822.0.SG.FAPT1.DLA](#) NSN: 8150-01-618-6803



Adaptor Plate Mounted on Both Sides Accepts any Two Full-Width Storage Modules or any Four Half-Width Storage Modules

P/N: [SB822.0.ST.FAPT2.DLA](#) NSN:8150-01-618-6816

P/N: [SB822.0.SG.FAPT2.DLA](#) NSN:8150-01-618-6809

- Patented adaptor plate system on one or both sides which provides a method to mount a full array of SEA BOX's Removable Storage Modules
- Container and adaptor plate available in Standard Tan or Standard Green

20' Two Full Side Opening Container with Adaptor Plates on One or Both Sides



Three Adaptor Plates Mounted on One Side
Accepts any Three Tricon Full-Width Storage Modules or any Six Tricon Half-Width Storage Modules. Other side of container has full opening doors for bulk item storage
P/N: [SB892.6.ST.APT3.DLA](#) NSN: 8150-01-620-7604
P/N: [SB892.6.SG.APT3.DLA](#) NSN: 8150-01-620-7316



Three Adaptor Plates Mounted on Both Sides
Accepts any Six Tricon Full-Width Storage Modules or any Twelve Tricon Half-Width Storage Modules
P/N: [SB892.6.ST.APT6.DLA](#) NSN: 8150-01-620-7912
P/N: [SB892.6.SG.APT6.DLA](#) NSN: 8150-01-620-7378

- 20' ISO containers provide the maximum amount of storage and transport space for small, medium, and large items!

20' PLS Two Full Side Opening Container with Adaptor Plates on One or Both Sides



Three Adaptor Plates Mounted on One Side
Accepts any Three Tricon Full-Width Storage Modules or any Six Tricon Half-Width Storage Modules. Other side of container has full opening doors for bulk item storage
P/N: [SB892.6.ST.PLSAPT3.DLA](#) NSN: 8150-01-620-7917
P/N: [SB892.6.SG.PLSAPT3.DLA](#) NSN: 8150-01-620-7429



Three Adaptor Plates Mounted on Both Sides
Accepts any Six Tricon Full-Width Storage Modules or any Twelve Tricon Half-Width Storage Modules
P/N: [SB892.6.ST.PLSAPT6.DLA](#) NSN: 8150-01-620-7923
P/N: [SB892.6.SG.PLSAPT6.DLA](#) NSN: 8150-01-620-7465

- 20' ISO containers with Palletized Load System (PLS) provide the maximum amount of storage and transport space for small, medium, and large items!

Tricon Sized Full or Half Width Adaptor Plates

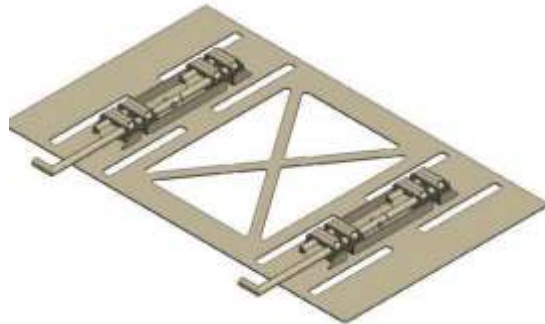

Full -Width Adaptor Plate Accepts any One Full-Width Storage Module or any Two Half-Width Storage Modules

P/N: [SB3453.FAPT.DLA](#) NSN: 8145-01-618-6819

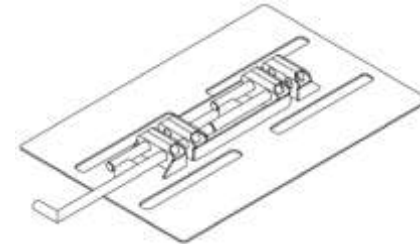

Half -Width Adaptor Plate Accepts any One Half-Width Storage Module

P/N: [SB3453.HAPT.DLA](#) NSN: 8145-01-618-6821

- Patented adaptor plate which mounts into a standard Tricon Type II (sold separately P/N: SB822.0) and provides a method to mount a full array of SEA BOX's Removable Storage Modules
- Adaptor Plate allows Removable Modules to be easily loaded, unloaded, and moved via forklift
- Plate features foolproof locking system which ensures that the doors of the container cannot be closed until the shot bolt mechanism is engaged correctly into the Removable Module
- Adaptor plate incorporates location and guide features to ensure that the Removable Module is in the correct position for transportation, eliminating the need for blocking and bracing
- In a matter of minutes, the Removable Modules are loaded, locked down and the container doors closed and ready for quick, product-safe deployment

Tricon Half-Width Drawer Modules



- Removable and transportable unit designed for efficient storage and transport of small and medium sized parts
- Half-Width Module with forklift pockets fits inside one half side of a standard ISO Tricon with Adaptor Plate (P/N: [SB822.0.ST.FAPT1.DLA](#)) or 20ft Container with Adaptor Plate (P/N# SB892.6 series)
- Module can be loaded into a container by a forklift and securely locked to the floor via adaptor plate for transport
- Module is easily removed from container and can be utilized in workshops, stores, maintenance shops or a warehouse on a daily basis, then replenished or re-set and returned to the container where it is securely locked down and ready for deployment.
- Fitted with full-height "Lockable Gates" used to lock drawers and shelves during deployment and to improve theft and pilferage protection while in transport mode and at point of use
- Module has a two point lock down security system
- Low profile base for maximum storage capacity
- Three Year Warranty



Tricon Half-Width Drawer Modules



- All drawers have 500 lb capacity and include partitioning kits which can be repositioned to adjust to load requirements
- Drawers are mounted on rails with the patented SuperGlide 500 which is a self-lubricating, self-cleaning system that is resistant to dust, rust, sand and dirt
- SuperGlide 500 system is long-lasting and virtually maintenance-free because it has no rotating parts that could wear out over time
- Drawers extend out 100% for easy access to all stored items

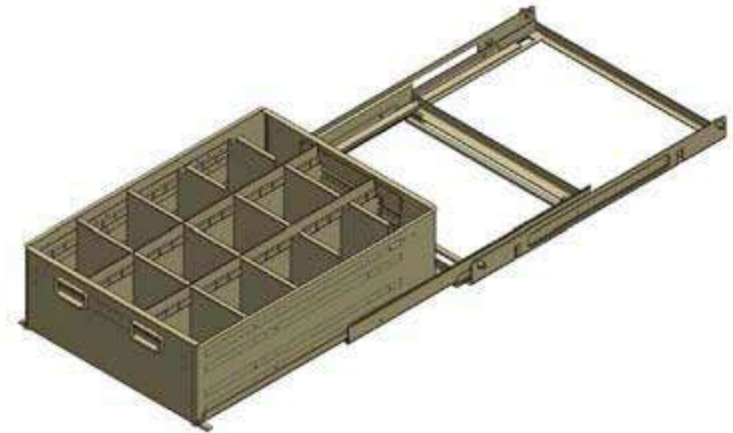

Tricon Half-Width Drawer Modules



Drawer Module 1

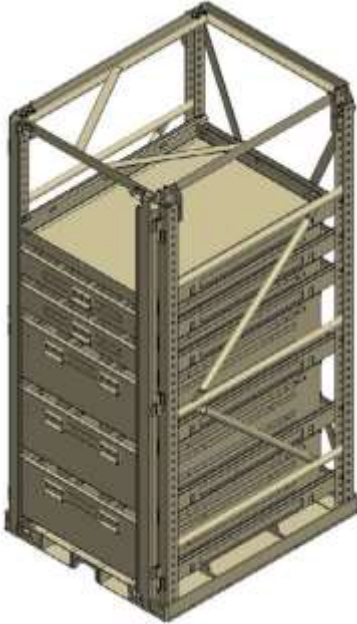

P/N: [SB3453.THDU-1.DLA](#)

NSN: 8145-01-618-6823

Module includes: (3) 11.2" H Drawers, (2) 4.7" H Drawers, and (1) Slide-Out Bulk Tray with net

Drawer Module 2

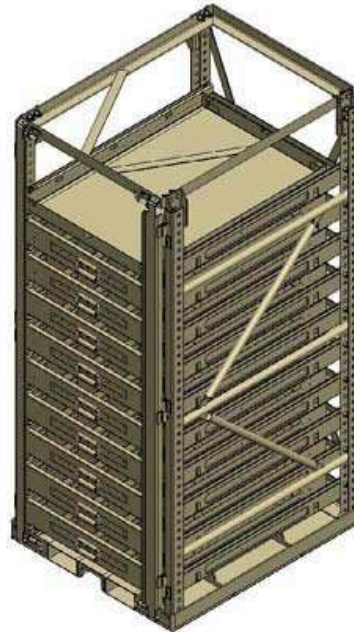

P/N: [SB3453.THDU-2.DLA](#)

NSN: 8145-01-618-6826

Module includes: (9) 4.7" H Drawers and (1) Slide-Out Bulk Tray with net

Drawer Module 3

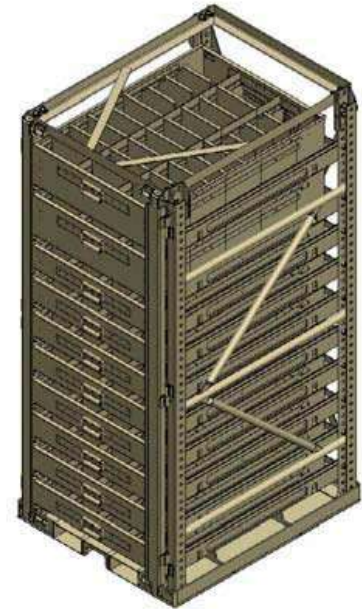

P/N: [SB3453.THDU-3.DLA](#)

NSN: 8145-01-618-6827

Module includes: (8) 4.7" H Drawers and (2) 8" H Drawers

Tricon Half-Width Drawer Modules (Cont'd)



Drawer Module 4

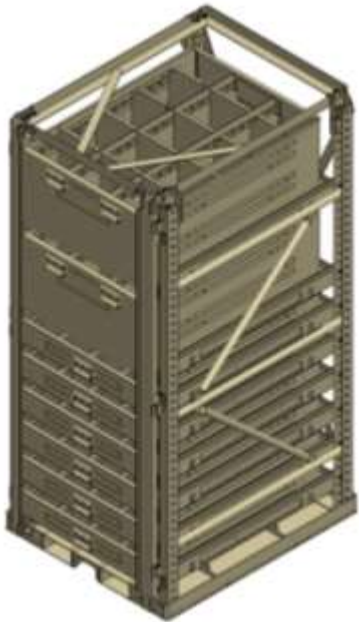

P/N: [SB3453.THDU-4.DLA](#)
NSN: 8145-01-618-6829
Module includes: (6) 4.7"H Drawers, (2) 14.5"H Drawers

Drawer Module 5

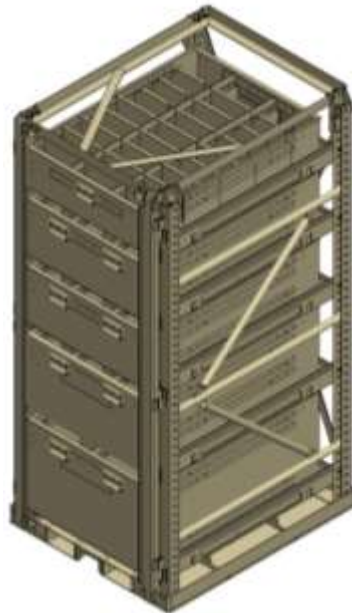

P/N: [SB3453.THDU-5.DLA](#)
NSN: 8145-01-618-6832
Module includes: (1) 17.5"H Drawer, (1) 14.5"H Drawer, (2) 11.2"H Drawers, (1) 8"H Drawer

Drawer Module 6



P/N: [SB3453.THDU-6.DLA](#)
NSN: 8145-01-618-6836
Module includes: (4) 14.5"H Drawers, (1) 4.7"H Drawer

Drawer Module 7



P/N: [SB3453.THDU-7.DLA](#)
NSN: 8145-01-618-6839
Module includes: (2) 17.5"H Drawers, (2) 14.5"H Drawers

Tricon Half-Width Weatherproof Drawer Modules



- All Drawers include weatherproof, gasket - sealed, lockable lids
- Lids are self-supporting with struts to allow user to operate with both hands while drawer is open
- All drawers have 500 lb capacity and include partitioning kits which can be repositioned to adjust to load requirements
- Drawers are mounted on rails with the patented SuperGlide500 which is a self-lubricating, self-cleaning system that is resistant to dust, rust, sand and dirt
- SuperGlide 500 system is long-lasting and virtually maintenance-free because it has no rotating parts that could wear out over time
- Drawers extend out 100% for easy access to all stored items

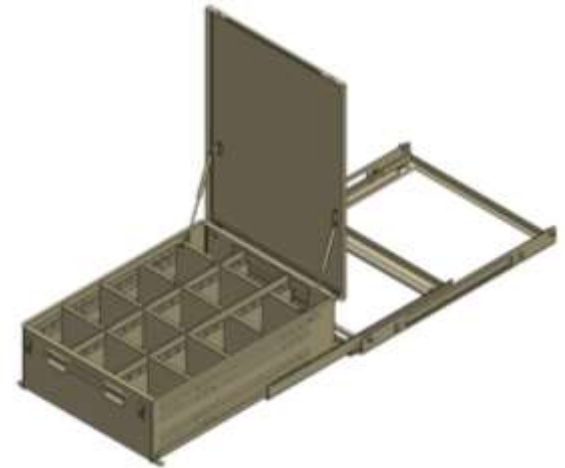

Tricon Half-Width Weatherproof Drawer Modules



Weatherproof Drawer Module 1

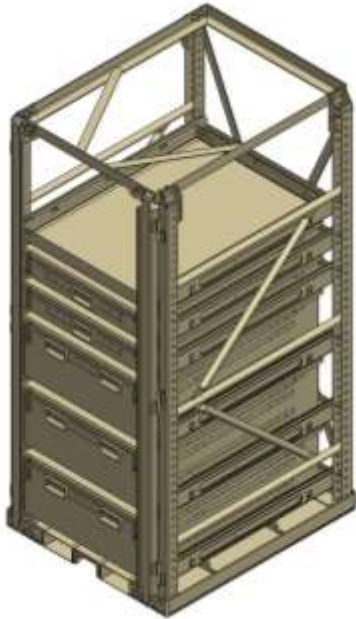

P/N: [SB3453.THWDU-1.DLA](#)

NSN: 8145-01-618-6840

Module includes: (3) 11.2" H Drawers, (2) 4.7" H Drawers, and (1) Slide-Out Bulk Tray with net. All drawers include weatherproof, lockable lids.

Weatherproof Drawer Module 2



P/N: [SB3453.THWDU-2.DLA](#)

NSN: 8145-01-618-6842

Module includes: (9) 4.7" H Drawers and (1) Slide-Out Bulk Tray with net. All drawers include weatherproof, lockable lids.

Weatherproof Drawer Module 3



P/N: [SB3453.THWDU-3.DLA](#)

NSN: 8145-01-618-7774

Module includes: (8) 4.7" H Drawers and (2) 8" H Drawers. All drawers include weatherproof, lockable lids.

Tricon Half-Width Weatherproof Drawer Modules (Cont'd)



**Weatherproof
Drawer Module 4**



P/N: [SB3453.THWDU-4.DLA](#)

NSN: 8145-01-618-7782

Module includes: (6) 4.7"H Drawers, (2) 14.5"H Drawers. All drawers include weatherproof, lockable lids.

**Weatherproof
Drawer Module 5**

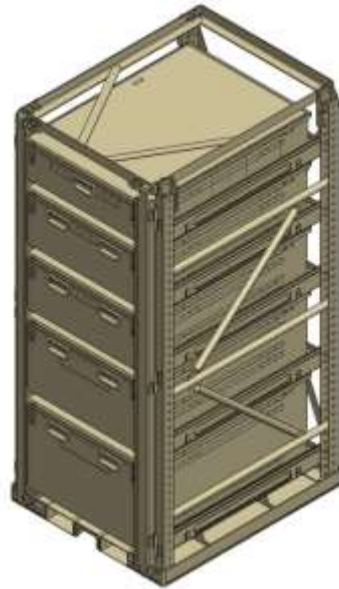

P/N: [SB3453.THWDU-5.DLA](#)

NSN: 8145-01-618-7789

Module includes: (1) 17.5"H Drawer, (1) 14.5"H Drawer, (2) 11.2"H Drawers, (1) 8"H Drawer. All drawers include weatherproof, lockable lids.

**Weatherproof
Drawer Module 6**



P/N: [SB3453.THWDU-6.DLA](#)

NSN: 8145-01-618-7813

Module includes: (4) 14.5"H Drawers, (1) 4.7"H Drawer. All drawers include weatherproof, lockable lids.

**Weatherproof
Drawer Module 7**



P/N: [SB3453.THWDU-7.DLA](#)

NSN: 8145-01-618-7819

Module includes: (2) 17.5"H Drawers, (2) 14.5"H Drawers. All drawers include weatherproof, lockable lids.

Tricon Half-Width StackaBox™ Modules



- All StackaBoxes have weatherproof, lockable lids which are self-supporting with gas struts and can withstand wind gusts up to 40mph
- StackaBoxes have a 250 lb capacity and include partitioning kits which can be repositioned to adjust to load requirements
- All StackaBoxes have handles to allow for easy removal and manual transport
- StackaBoxes securely lock into the SuperGlide 500 rail system, which is a patented, self-lubricating, self-cleaning system that is resistant to dust, rust, sand and dirt
- SuperGlide 500 rail system has no rotating parts which could wear over time making it long-lasting and virtually maintenance-free

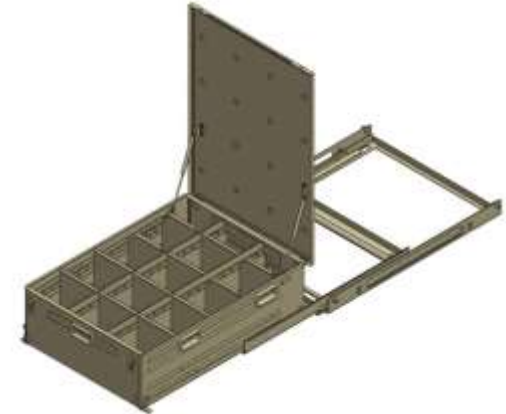

Tricon Half-Width StackaBox™ Modules



StackaBox Module 1

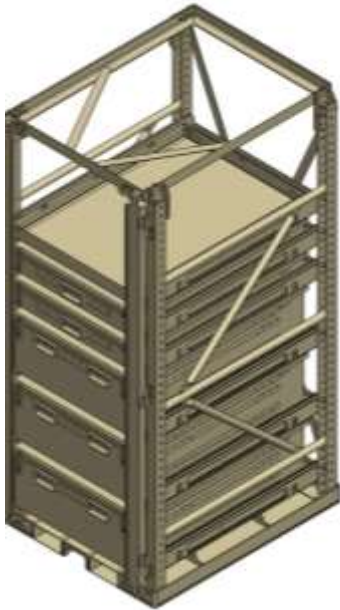

P/N: [SB3453.THSU-1.DLA](#)

NSN: 8145-01-618-7519

Module includes: (3) 11.2" H StackaBoxes, (2) 4.7" H StackaBoxes, and (1) Slide-Out Bulk Tray with net.

StackaBox Module 2

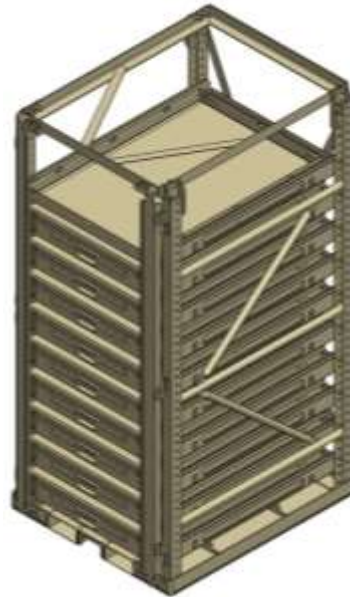

P/N: [SB3453.THSU-2.DLA](#)

NSN: 8145-01-618-7524

Module includes: (9) 4.7" H StackaBoxes and (1) Slide-Out Bulk Tray with net.

StackaBox Module 3



P/N: [SB3453.THSU-3.DLA](#)

NSN: 8145-01-618-7530

Module includes: (8) 4.7" H StackaBoxes and (2) 8"H StackaBoxes.

Tricon Half-Width StackaBox™ Modules (Cont'd)



StackaBox Module 4



P/N: [SB3453.THSU-4.DLA](#)

NSN: 8145-01-618-7533

Module includes: 6) 4.7"H StackaBoxes, (2) 14.5"H StackaBoxes.

StackaBox Module 5



P/N: [SB3453.THSU-5.DLA](#)

NSN: 8145-01-618-7536

Module includes: (1) 17.5"H StackaBox, (1) 14.5"H StackaBox, (2) 11.2"H StackaBoxes, (1) 8"H StackaBox

StackaBox Module 6



P/N: [SB3453.THSU-6.DLA](#)

NSN: 8145-01-618-7702

Module includes: (4) 14.5"H StackaBoxes, (1) 4.7"H StackaBox.

StackaBox Module 7



P/N: [SB3453.THSU-7.DLA](#)

NSN: 8145-01-618-7708

Module includes: (2) 17.5"H StackaBoxes, (2) 14.5"H StackaBoxes.

Tricon Full-Width Glide-Out Modules



- Removable and transportable unit designed for efficient storage and transport of medium and large sized parts, tools, or supplies
- Each shelf extends out 70%, has a 2,250lbs capacity, and includes a cargo net.
- When the shelf is fully retracted into the Glide-Out slide it is automatically restrained in all directions.
- Glide-Out Shelves can be repositioned and reconfigured as mission demands change.
- Half-Width Module with forklift pockets fits inside one full side of a standard ISO Tricon with Adaptor Plate (P/N [SB822.0.ST.FAPT1.DLA](#))
- Fitted with full-height "Lockable Gates" used to lock shelves during deployment
- Low profile base for maximum storage capacity

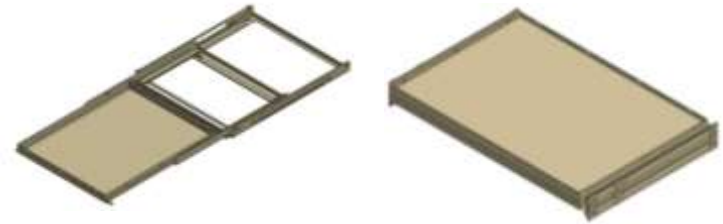

Tricon Full-Width Glide-Out Modules



Glide-Out Module 1

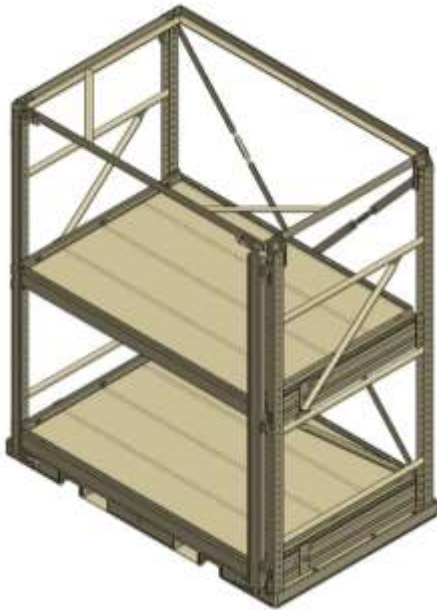

P/N: [SB3453.TFGO-1.DLA](#)

NSN: 8145-01-618-7466

Module includes: (2) Glide-Out Shelves with standard trays (1.5" lip) and (2) cargo nets.

Glide-Out Module 2

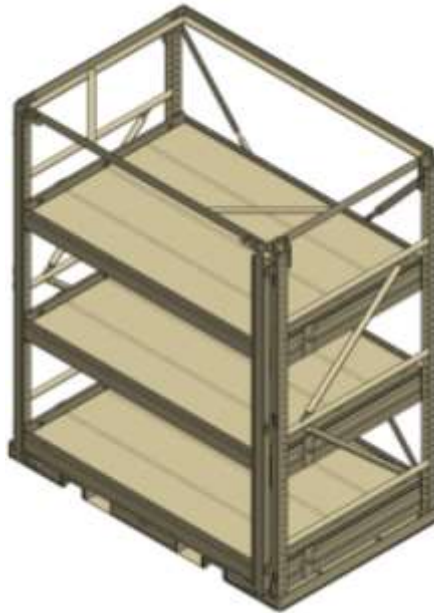

P/N: [SB3453.TFGO-2.DLA](#)

NSN: 8145-01-618-7469

Module includes: (3) Glide-Out Shelves with standard trays (1.5" lip) and (3) cargo nets.

Glide-Out Module 3

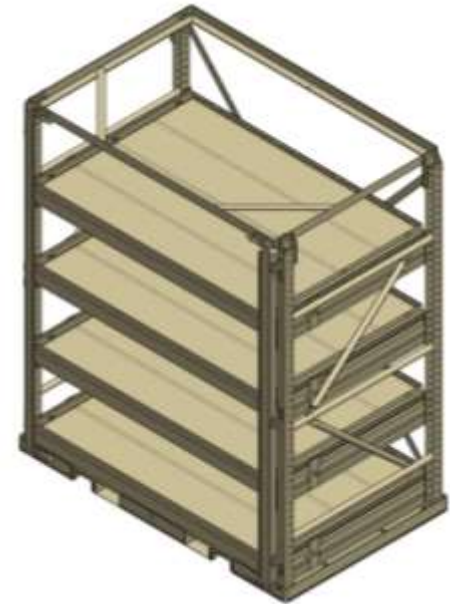

P/N: [SB3453.TFGO-3.DLA](#)

NSN: 8145-01-618-7472

Module includes: (4) Glide-Out Shelves with standard trays (1.5" lip) and (4) cargo nets.

Tricon Full-Width Glide-Out Modules (Cont'd)



Glide-Out Module 4

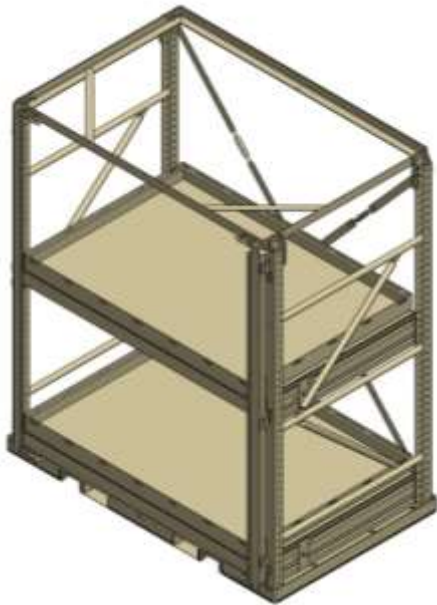

P/N: [SB3453.TFGO-4.DLA](#)

NSN: 8145-01-618-7477

Module includes: (2) Glide-Out Shelves with containment trays (4.5" lip) for battery storage and (2) cargo nets.

Glide-Out Module 5

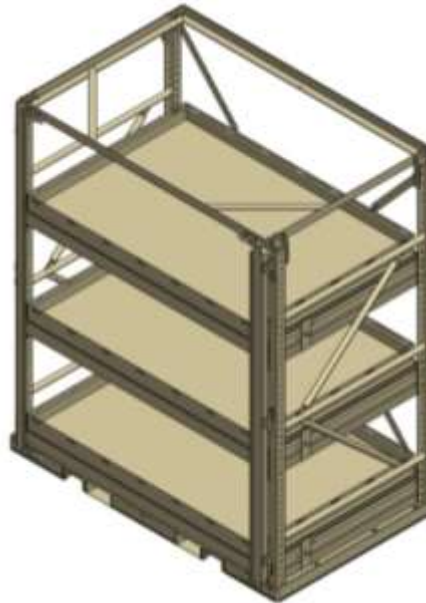

P/N: [SB3453.TFGO-5.DLA](#)

NSN: 8145-01-618-7480

Module includes: (3) Glide-Out Shelves with containment trays (4.5" lip) for battery storage and (3) cargo nets.

Glide-Out Module 6

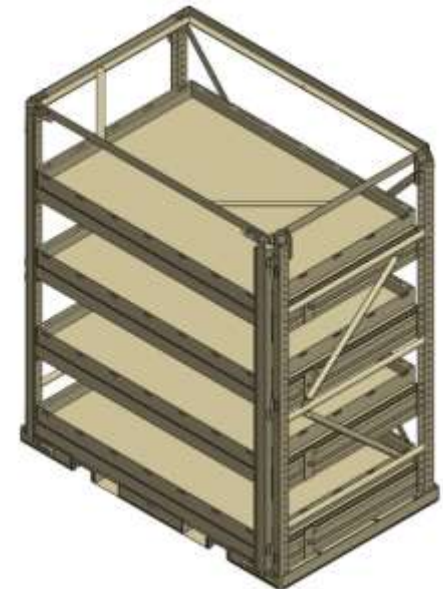

P/N: [SB3453.TFGO-6.DLA](#)

NSN: 8145-01-618-7483

Module includes: (4) Glide-Out Shelves with containment trays (4.5" lip) for battery storage and (4) cargo nets.

Tricon Module Dimensions



Half-Width Module Dimensions

	Depth	Width	Height
In.	44	36	80
Cm.	112	91	203

Full-Width Module Dimensions

	Depth	Width	Height
In.	44	69.5	80
Cm.	111.8	176.5	203.2

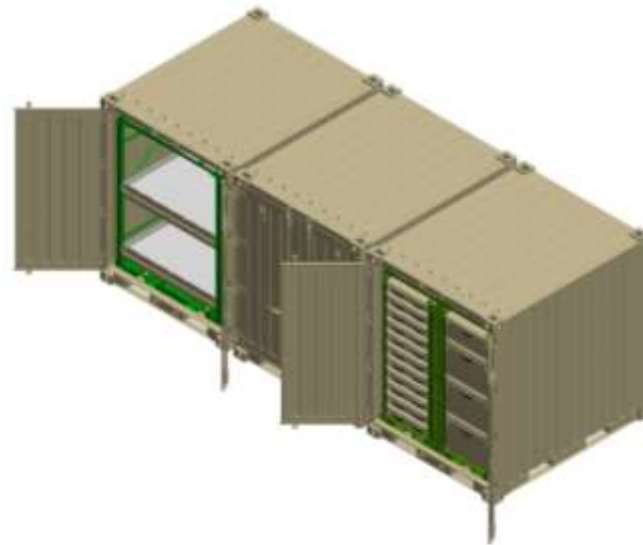

Tricon Module Weights and Capacities



SEA BOX Part No.	Weight (lbs)	Capacity (lbs)
SB3453.THDU-1.DLA	1044	3000
SB3453.THDU-2.DLA	1425	5000
SB3453.THDU-3.DLA	1508	5000
SB3453.THDU-4.DLA	1320	4000
SB3453.THDU-5.DLA	1036	2500
SB3453.THDU-6.DLA	1043	2500
SB3453.THDU-7.DLA	936	2000
SB3453.THWDU-1.DLA	1044	3000
SB3453.THWDU-2.DLA	1425	5000
SB3453.THWDU-3.DLA	1508	5000
SB3453.THWDU-4.DLA	1320	4000
SB3453.THWDU-5.DLA	1036	2500
SB3453.THWDU-6.DLA	1043	2500
SB3453.THWDU-7.DLA	936	2000

SEA BOX Part No.	Weight (lbs)	Capacity (lbs)
SB3453.THSU-1.DLA	1034	1750
SB3453.THSU-2.DLA	1416	2750
SB3453.THSU-3.DLA	1488	2500
SB3453.THSU-4.DLA	1304	2000
SB3453.THSU-5.DLA	1026	1250
SB3453.THSU-6.DLA	1033	1250
SB3453.THSU-7.DLA	928	1000
SB3453.TFGO-1.DLA	919	4500
SB3453.TFGO-2.DLA	1131	6750
SB3453.TFGO-3.DLA	1143	9000
SB3453.TFGO-4.DLA	999	4500
SB3453.TFGO-5.DLA	1251	6750
SB3453.TFGO-6.DLA	1503	9000



SEA BOX, Inc.

1 SEA BOX Drive

East Riverton, NJ 08077-1910

Phone: 856-303-1101 Fax: 856-303-1501

Email: Sales@seabox.com